

Catalogue de clés à point

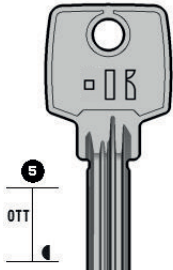

CATALOGUE DE CLÉS A POINT

ABUS



ABU49

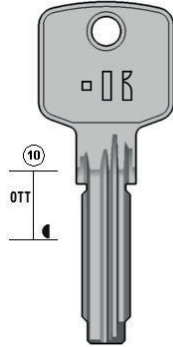

ABU47

ABU74

ABU77

NEW ABU80

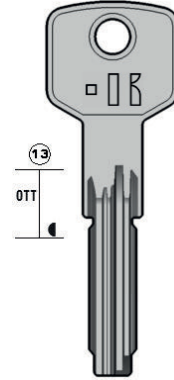

ABU48

AGB

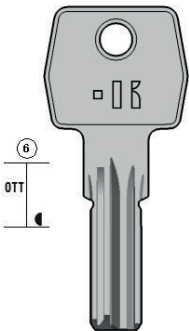

AGB7

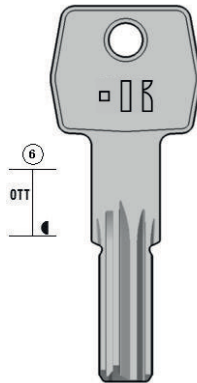

AGB9

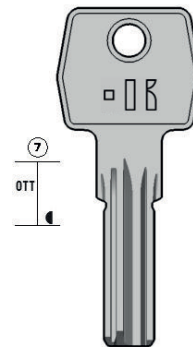

AGB6

AGB

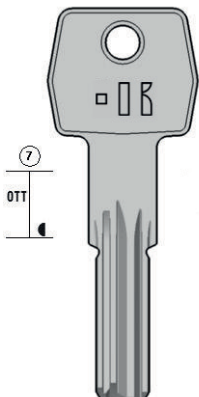

AGB8

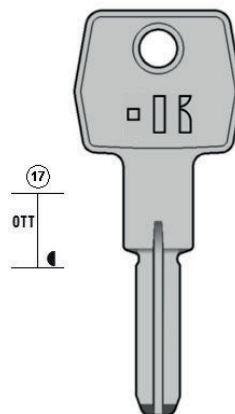

AGB1

CATALOGUE DE CLÉS A POINT

AMIG

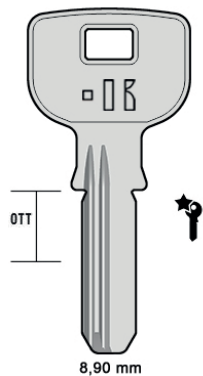

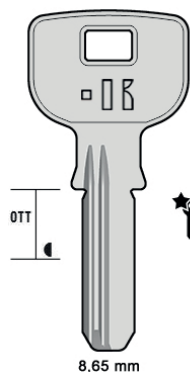

NEW AMG1



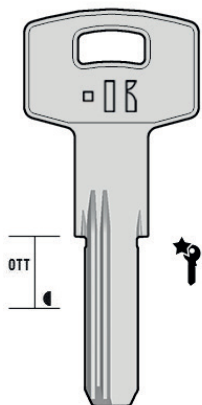

NEW AMG3

APEX



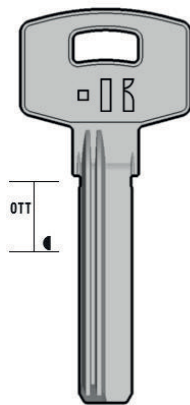

NEW APX2



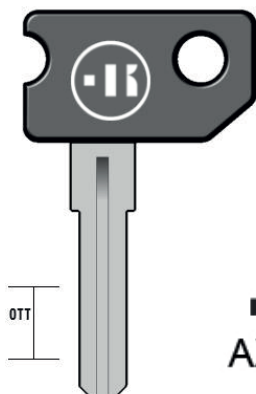

APX4

AXA

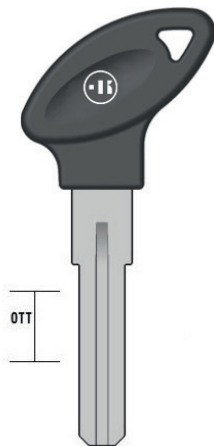

AXA1P





AXA1BP

AXA6P

CATALOGUE DE CLÉS A POINT

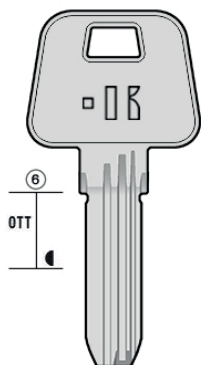
AZBE



HS7

AZ6

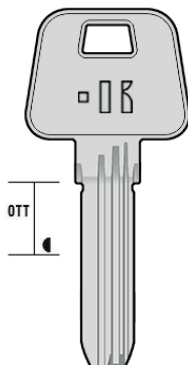

HS6

AZ7

BASI

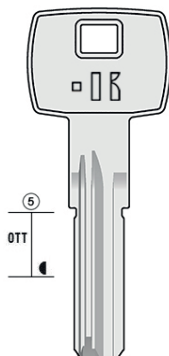

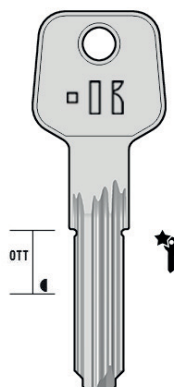

BA10

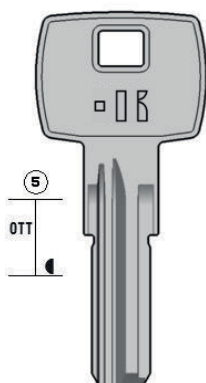

NEW BA11

BASSI





MRI2

CATALOGUE DE CLÉS A POINT

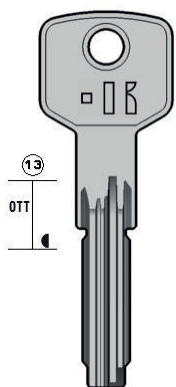
BRICARD

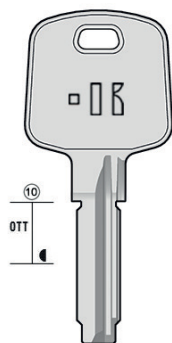

W05
BD20



Z76
BD21
Z36
BD16
Z75
BD13

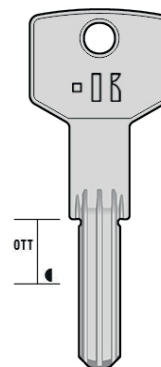

71
BD14
74
BD110

BURG

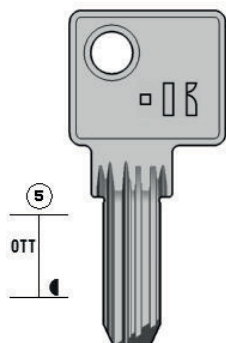

BU12

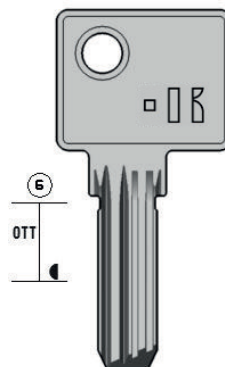

BU13

CANTOL

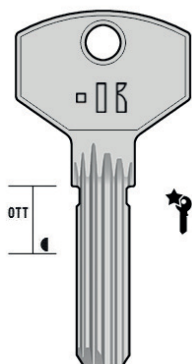

NEW CTO4

CATALOGUE DE CLÉS A POINT

CISA

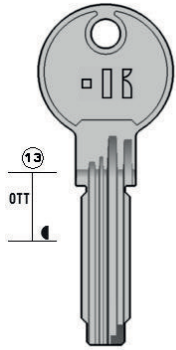

CA87

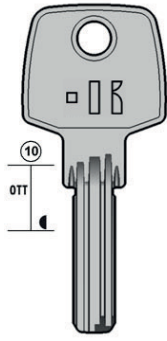

CA48

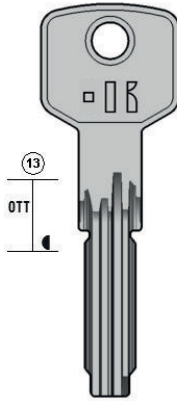

CA62



CA57



CA56



CA55



CA70



CA65

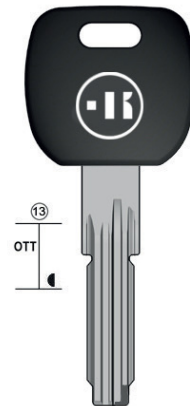

CA75P
CA70P
CA62P

CISA

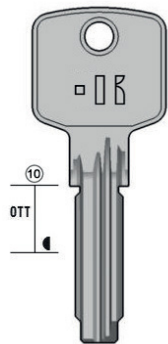

CA91



CA144

CORBIN

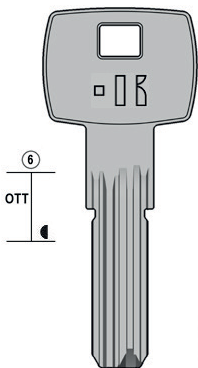

COR87

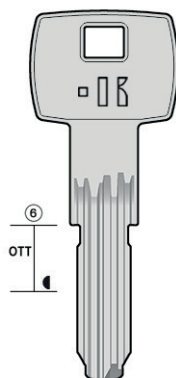



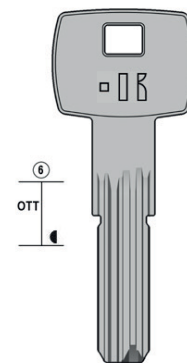





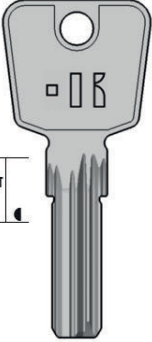

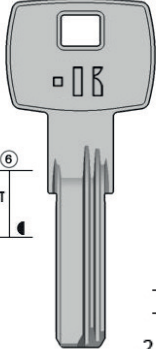

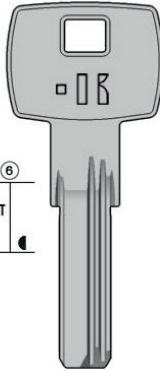

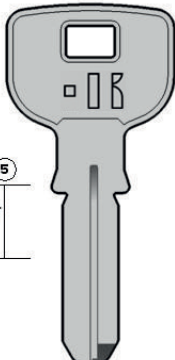
COR97B

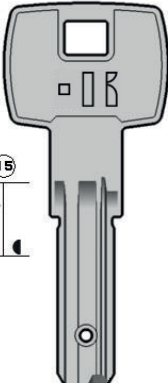

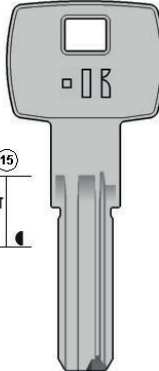
COR97

CATALOGUE DE CLÉS A POINT

CR	DEKABA	
 <p>OTT</p>  <p>TIN7</p>	 <p>OTT</p>  <p>2,50 mm Thickness DK6B</p>	 <p>OTT</p>  <p>2,32 mm Thickness DK6</p>
DELCA		
 <p>OTT</p>  <p>DL1S</p>  <p>DL2</p>		
DOM		
 <p>OTT</p>  <p>IX5 DO100X</p>  <p>OTT</p>  <p>DO100</p>  <p>DO120</p>  <p>DO24</p>		

CATALOGUE DE CLÉS A POINT

DOMUS

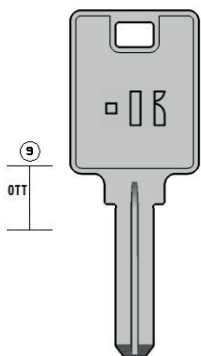

DS 1



DS 2

EURO-LOCKS

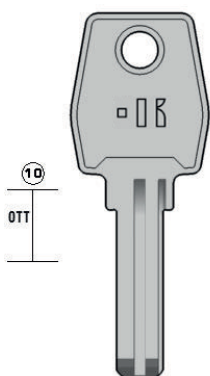

EU8



NEW EU15P

EZCURRA

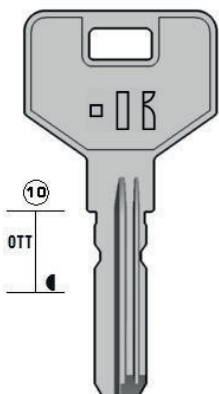



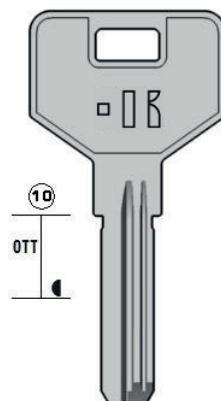





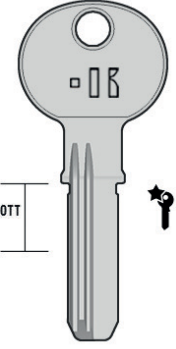

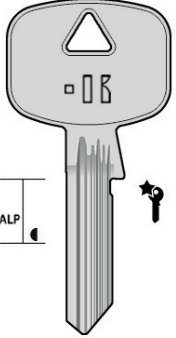

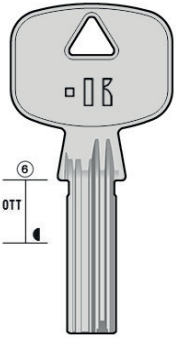

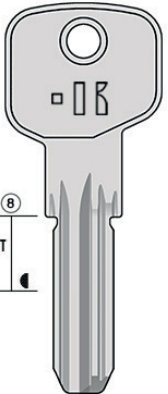
ER4

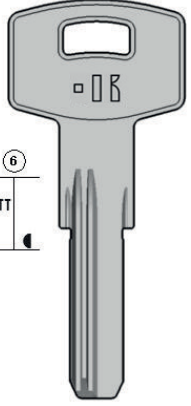

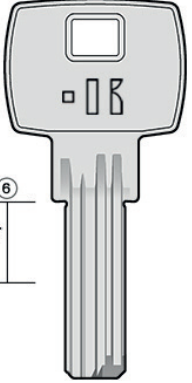
ER5

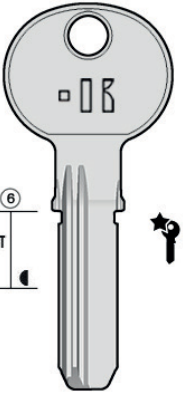
CATALOGUE DE CLÉS A POINT

FAVOUR	FCV	
 <p>OTT</p>  <p>NEW FR2</p>	 <p>ALP</p>  <p>NEW FV6S</p>  <p>NEW FV5S</p>	 <p>OTT</p>  <p>FV4</p>
FF-FACCHINETTI	FIAM	
 <p>OTT</p>  <p>FF19</p>	 <p>OTT</p>  <p>FIA7</p>  <p>FIA3S</p>	
FTH		
 <p>OTT</p>  <p>FTH12</p>	 <p>OTT</p>  <p>NEW FTH17</p>	

CATALOGUE DE CLÉS A POINT

GIUSSANI

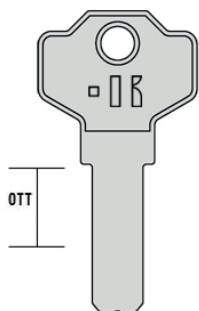

GIS12

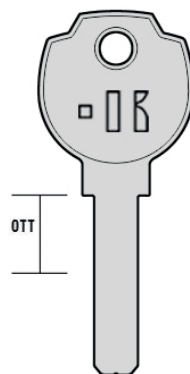

GIS17

ICSA

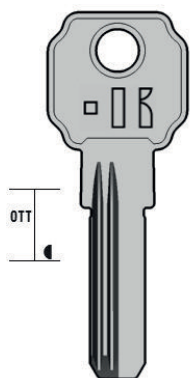

IC1

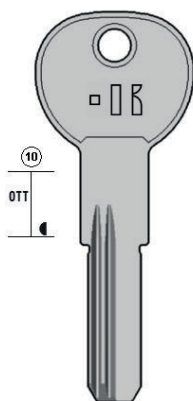

IC2

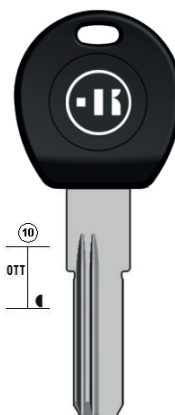

IC2P

ISEO

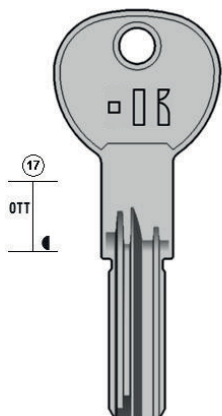

ISE30
R11+R7
ISE14
R6
ISE15
ISE17

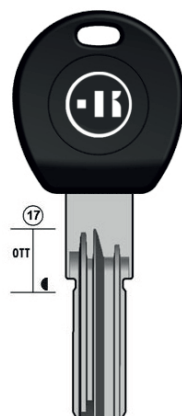

R6
ISE15P
ISE17P
R11+R7
ISE14P

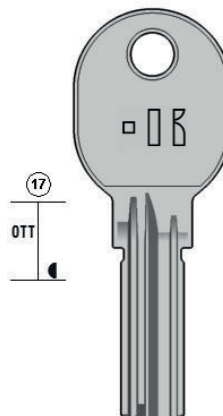

R6
ISE20

CATALOGUE DE CLÉS A POINT

KABA

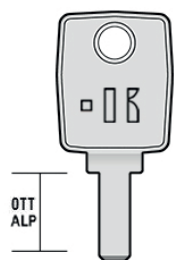

KA8
MICRO KABA

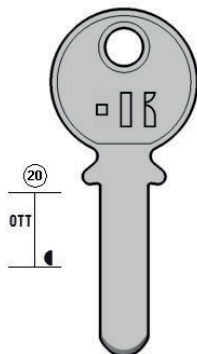

KA2

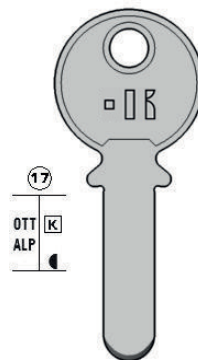

KA1

KALE

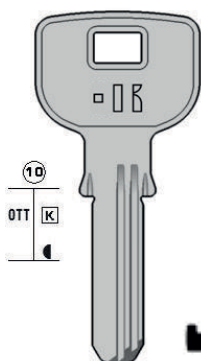

KE1

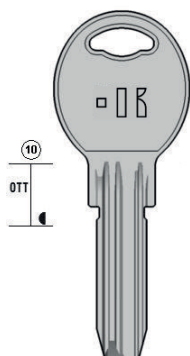

KE11
KE10S

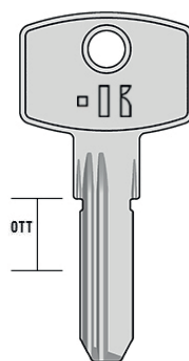

KE8

KESO

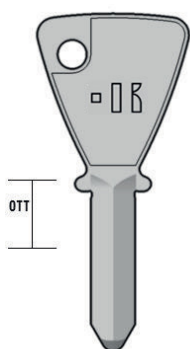

KS1

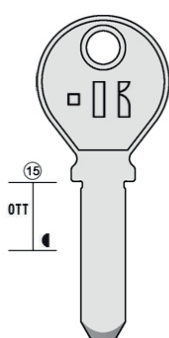

KS2

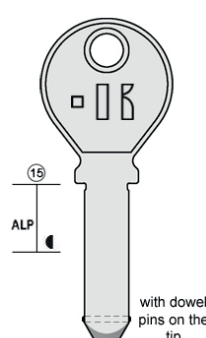

KS2X

CATALOGUE DE CLÉS A POINT

KESO

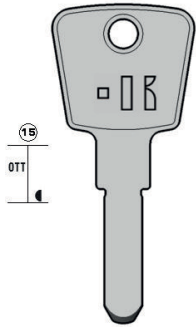

KS13

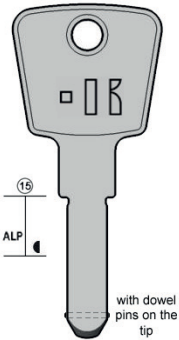

KS13X

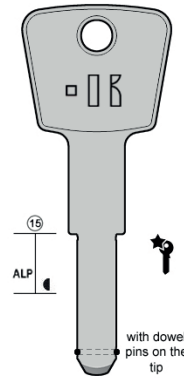

NEW KS13XL

KESO

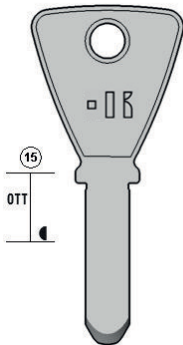

KS3

LAPERCHE

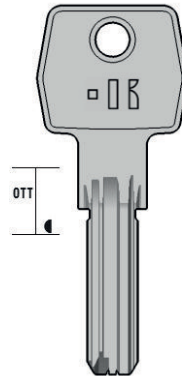

LR11

LEGALLIAIS

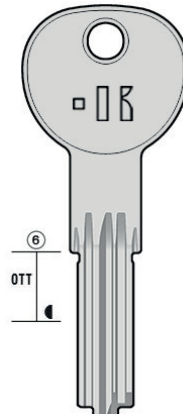

LEA1

LINCE

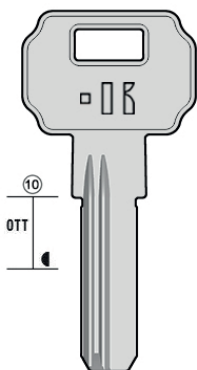



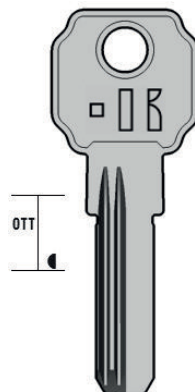





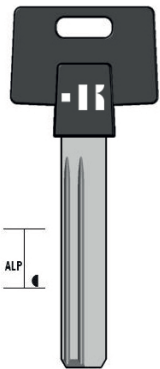

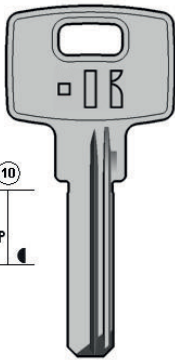

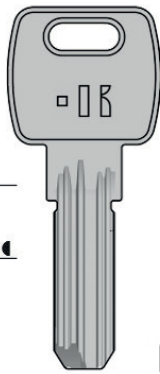

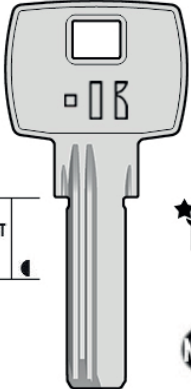
LIN1

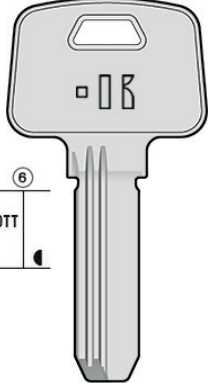

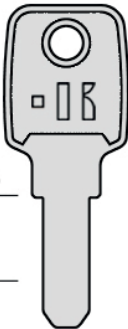
IC1

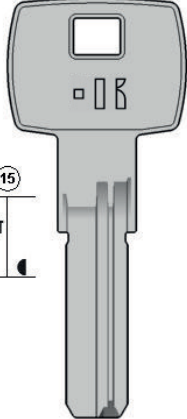
CATALOGUE DE CLÉS A POINT

MAGNUM	MAUER	
 <p>ALP</p>  <p>MGN1SP</p>	 <p>10 ALP</p>  <p>MA1S</p>	
MCM		
 <p>12 OTT</p>  <p>MC15S</p>	 <p>OTT</p>  <p>NEW MC14S</p>	 <p>6 OTT</p>  <p>MC10S</p>
MERONI	METAL	
 <p>4 OTT</p>  <p>ME39</p>	 <p>15 OTT</p>  <p>MET2</p>	

CATALOGUE DE CLÉS A POINT

MG MONTI

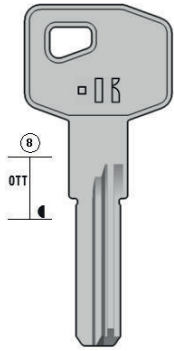

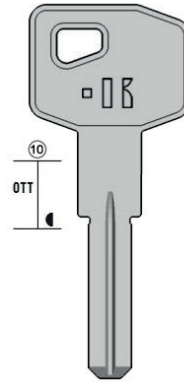

MN2S



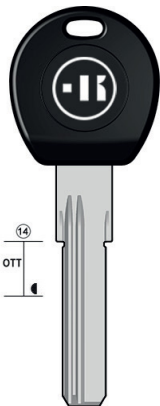

MN9

MOIA



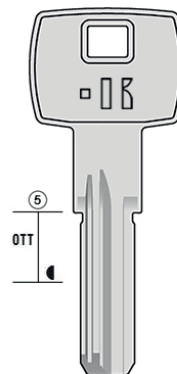

MOI1P

MORI G.

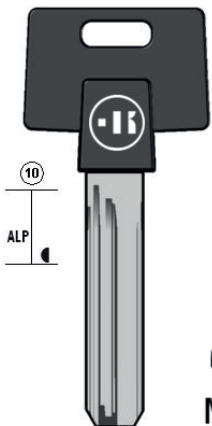

MRI1

MUL.T.LOCK





ML13P

ML8P

ML7P



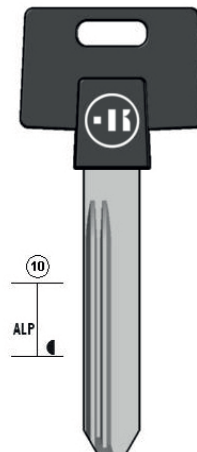







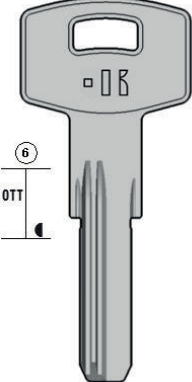

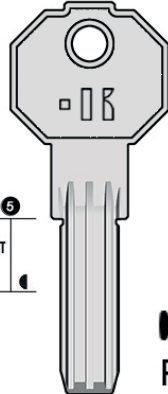

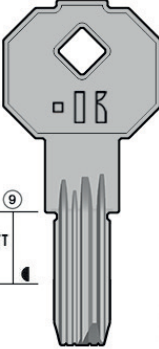

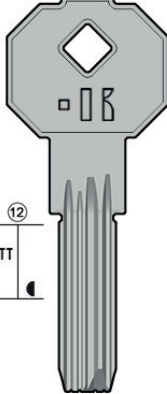

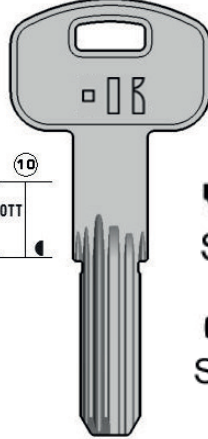
ML6P

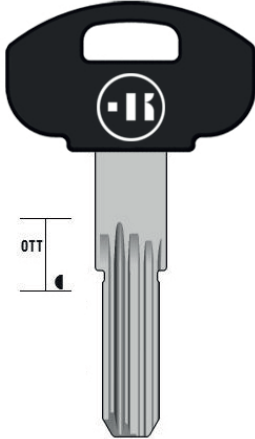
ML4P

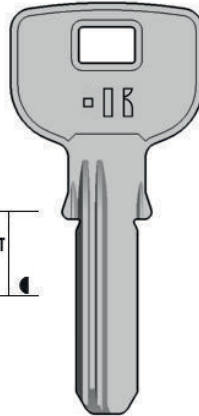

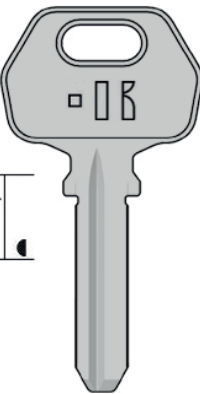







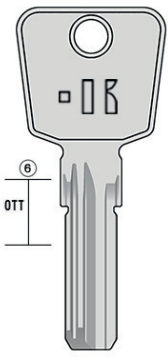

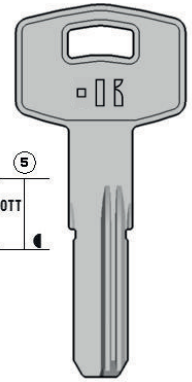

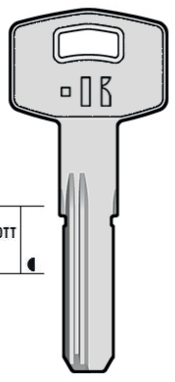

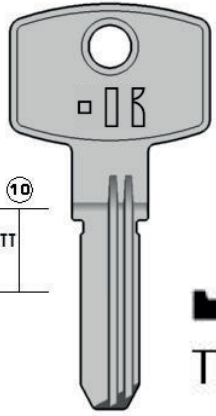

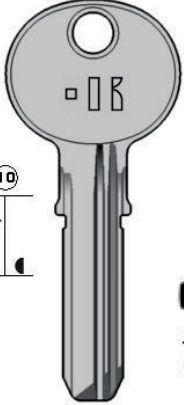

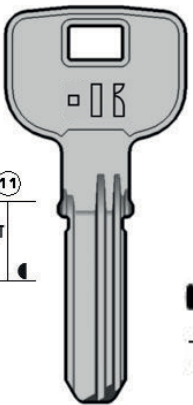

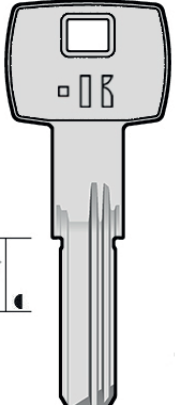
ML41P

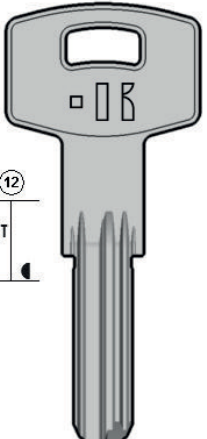
CATALOGUE DE CLÉS A POINT

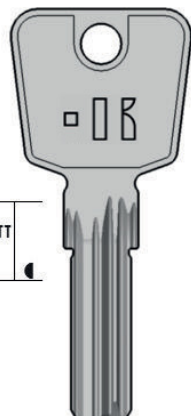
NOORI	PREFER		
 <p>6 OTT</p>  <p>FIA7</p>	 <p>5 OTT</p>  <p>PR16</p>	 <p>9 OTT</p>  <p>PR18</p>	 <p>12 OTT</p>  <p>PR17</p>
SECUREMME			
 <p>10 OTT</p>  <p>SEC9</p>  <p>SEC10</p>	 <p>OTT</p>  <p>K2 SEC11P</p>		
SP	SPIDER		
 <p>OTT</p>  <p>SP1</p>  <p>SP1S</p>	 <p>OTT</p>  <p>SPD1</p>  <p>SPD1S</p>		

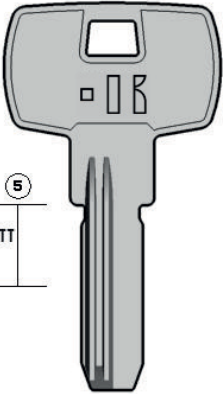
CATALOGUE DE CLÉS A POINT

SUDMETALL	TARONI	
 <p>6 OTT</p>  <p>SDM1</p>	 <p>5 OTT</p>  <p>TAR7S</p>  <p>TAR7</p>	 <p>OTT</p>  <p>TAR16</p>
TESA		
 <p>10 OTT</p>  <p>TES8</p>	 <p>10 OTT</p>  <p>TES7</p>	 <p>11 OTT</p>  <p>TES4</p>  <p>OTT</p>  <p>TES19</p>
THIRARD	TITAN	TOPEX
 <p>12 OTT</p>  <p>THR1</p>	 <p>OTT</p>  <p>TIN7</p>	 <p>5 OTT</p>  <p>TPX1</p>

CATALOGUE DE CLÉS A POINT

TRELOK



TRK4P

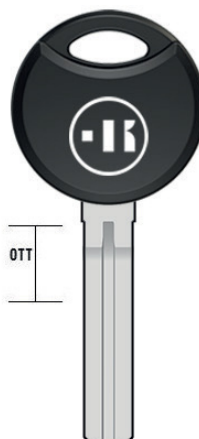

TRK5P
RS430

UCEM

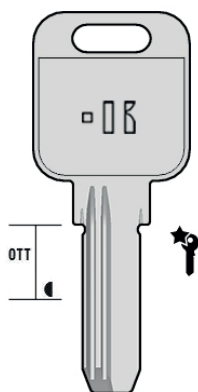

NEW UM4

VACHETTE

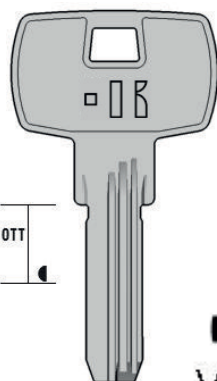

VC30S

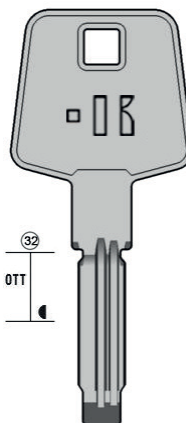

VC15
VC20

VBH

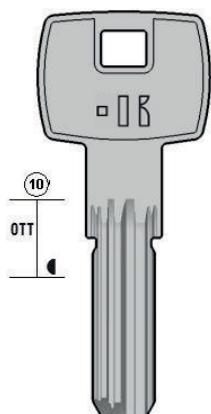

VBH1

VIRO

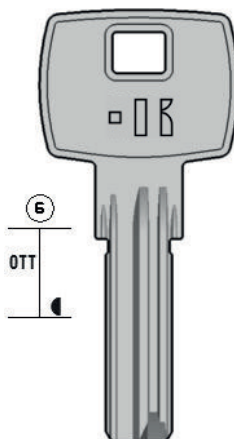

VR19

CATALOGUE DE CLÉS A POINT

YALE

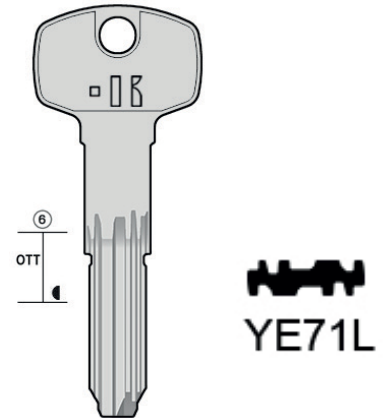
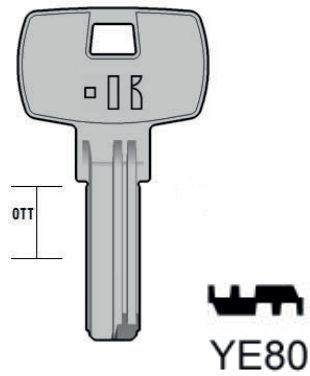
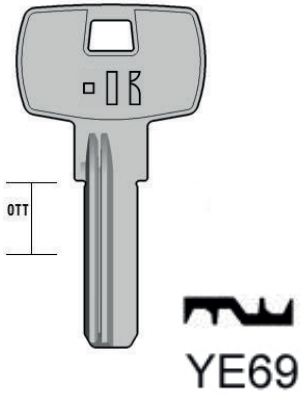

YALE

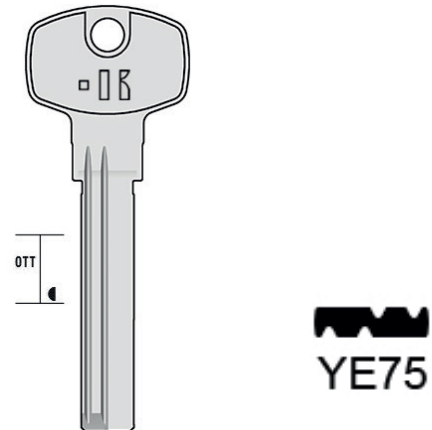
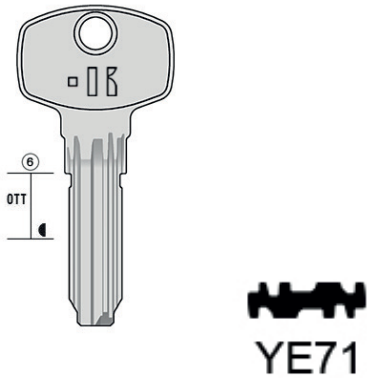

YARDENI

